

Le bélier

D'Eric Vigier.

(2005)

1

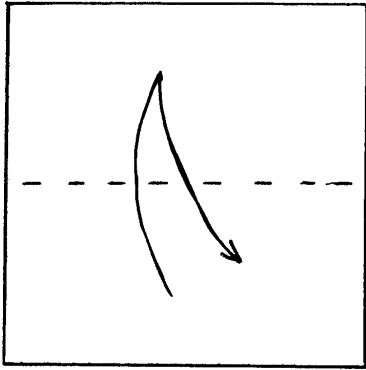

2

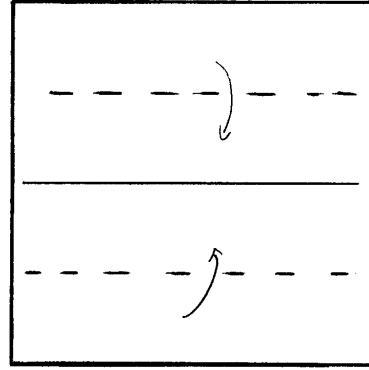

3

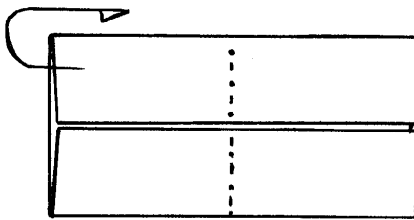

4

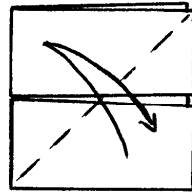

5

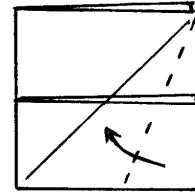

6

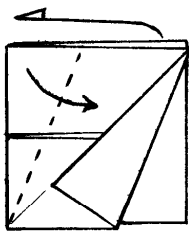

7

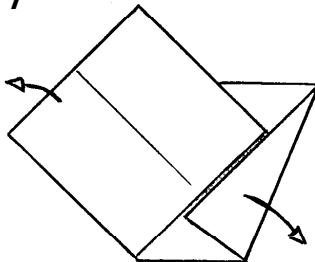

8

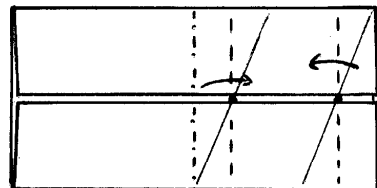

9

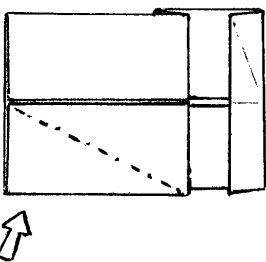

10

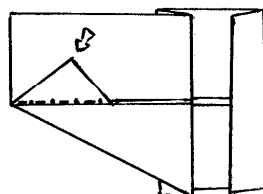

11

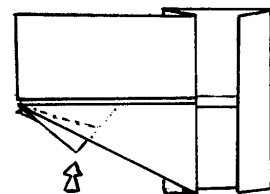

12

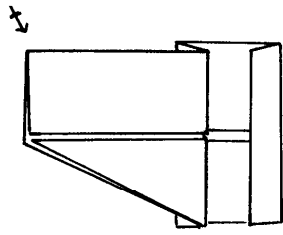

13

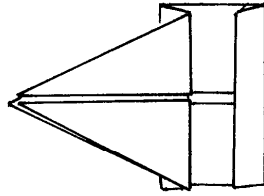

14

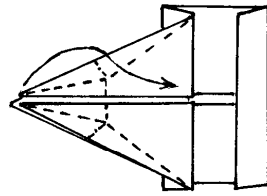

15

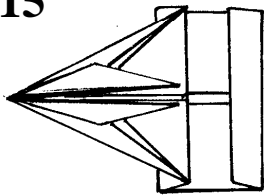

16

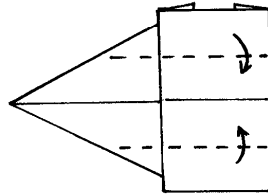

Déplier l'étape 14 et retourner le modèle.

17

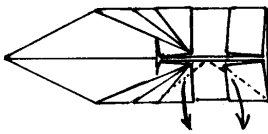

18

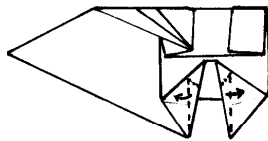

19

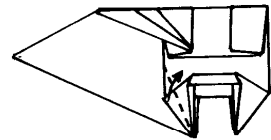

20

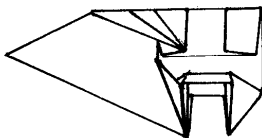

21

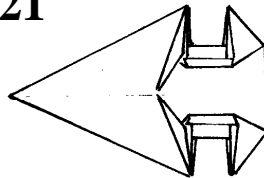

22

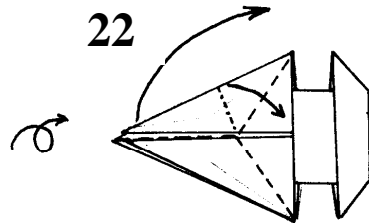

Répéter les opérations 17 à 19.

23

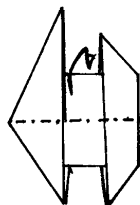

24

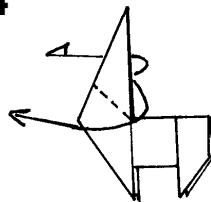

25

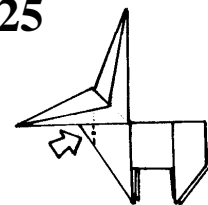

26

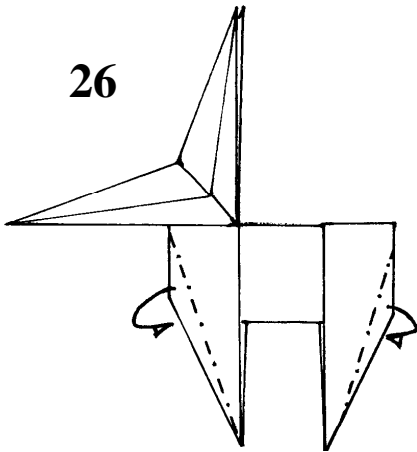

Répéter derrière.

27

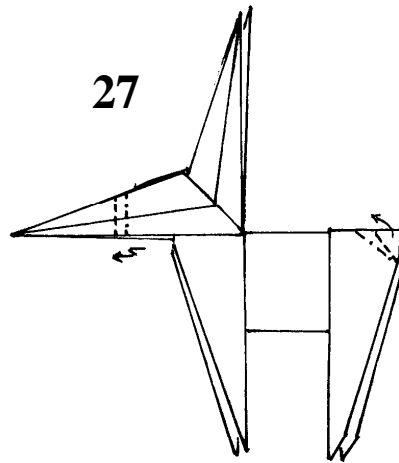

28

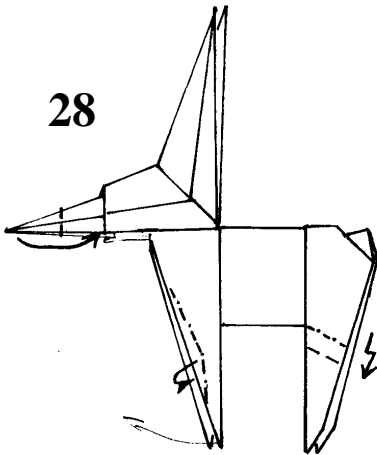

Répéter derrière.

29

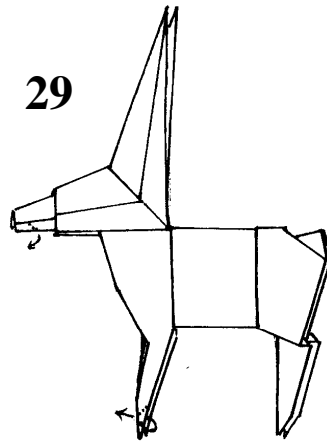

Répéter derrière.

30

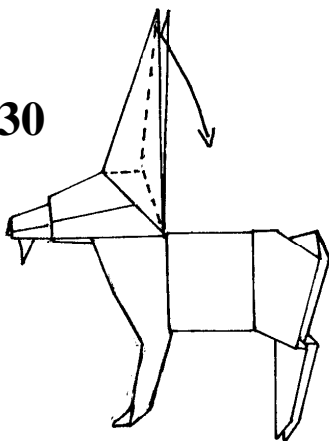

Pli oreille de lapin.
Répéter derrière.

31

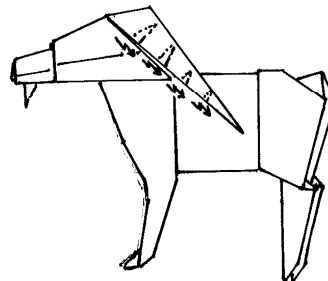

Répéter derrière.

32

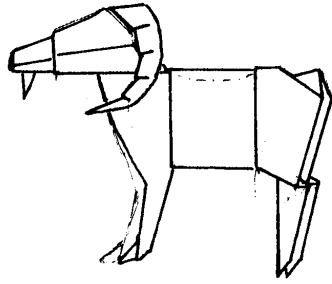

Pour le modelage final arrondir toute la tête.
Vous pouvez remonter les cornes plus haut
sur la tête.

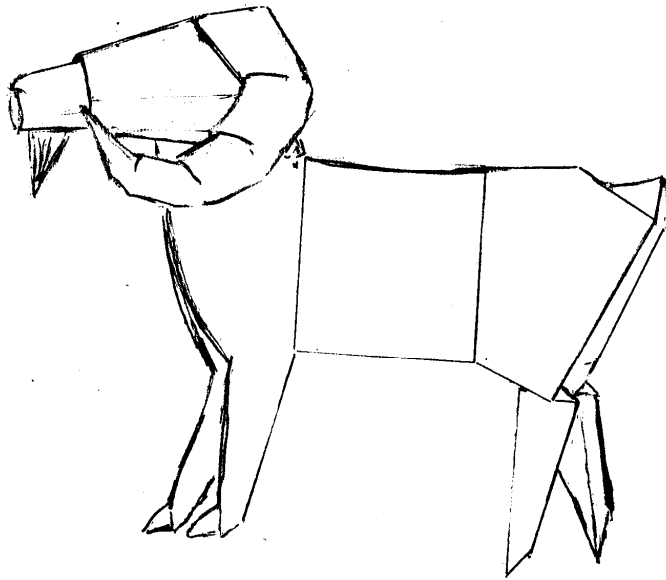

Le bélier terminé.