

Atelier d'Origami

Petite enveloppe carrée

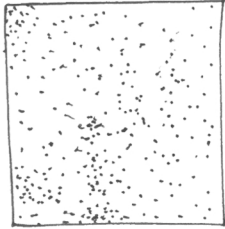

je prends une feuille carrée à origami
(12 x 12 cm ou 15 x 15 cm)

plier selon les pointillés

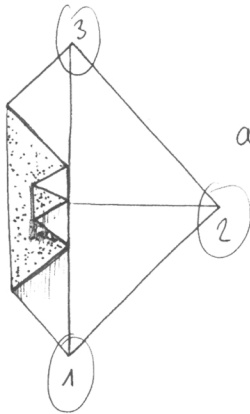
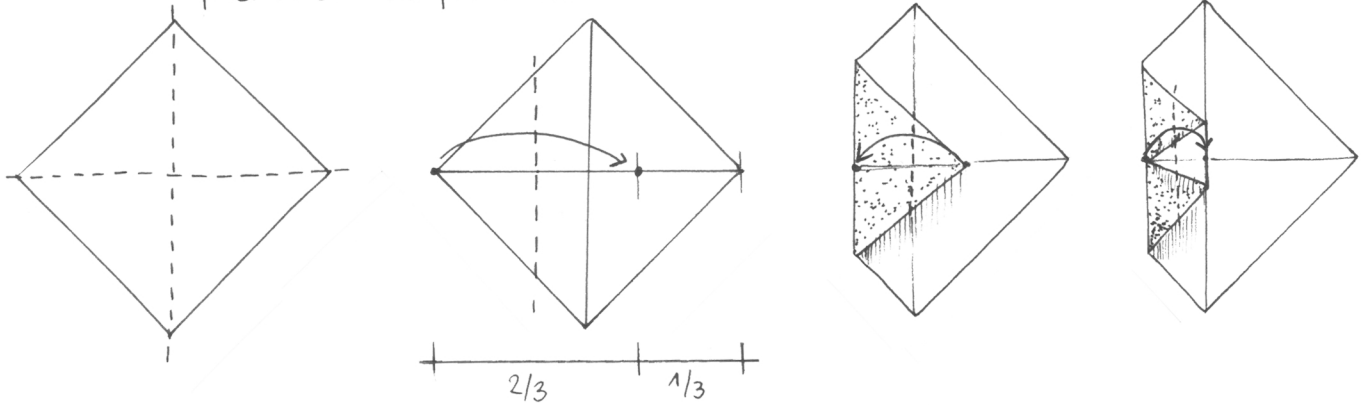

faire les mêmes plis
aux trois angles restants
(selon l'ordre indiqué)

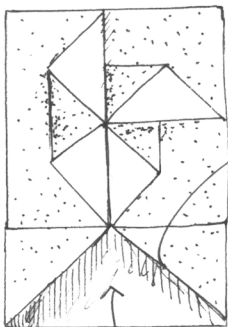
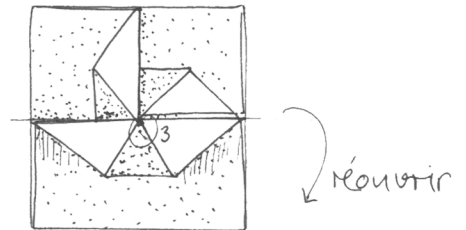

replier en glissant
l'angle droit sous la partie soulevée

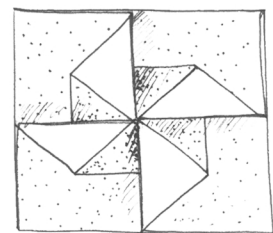
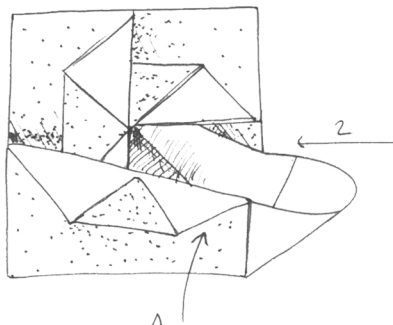

Kristina